

## **FULL-DEPTH, PRECAST, PRESTRESSED BRIDGE DECK PANEL SYSTEM FOR BRIDGE CONSTRUCTION IN WISCONSIN**

**Scott M. Markowski**, Dept. of Civil Engineering, University of Wisconsin–Madison

**Forrest G. Ehmke**, Dept. of Civil Engineering, University of Wisconsin–Madison

**Michael G. Oliva**, Dept. of Civil Engineering, University of Wisconsin–Madison

**James W. Carter III**, Alfred Benesch & Company, Kenosha, Wisconsin

**Lawrence C. Bank**, Dept. of Civil Engineering, University of Wisconsin–Madison

**Jeffrey S. Russell**, Dept. of Civil Engineering, University of Wisconsin–Madison

**Stanley Woods**, Wisconsin Department of Transportation, Madison, Wisconsin

**Roger Becker**, Spancrete Industries, Waukesha, Wisconsin

### **ABSTRACT**

*Increasing national attention is being drawn towards methods of rapid bridge repair and construction. Issues of motorist inconvenience and work zone safety demand that faster and more efficient construction procedures be implemented.*

*This paper describes a novel application of full-depth precast/pre-tensioned and post-tensioned deck panels for rapid bridge widening and replacement of an existing cast-in-place concrete deck on steel girders. The bridge is on a high volume Interstate highway. The need to provide for continuous traffic demanded a staged construction approach. This appeared to be a situation where the public could benefit from a rapid replacement method.*

*The University of Wisconsin team proposed some key innovative design concepts that are new in full depth precast decks. The first innovation is in the design and construction of the longitudinal deck joint that was required for the staged construction. A system was developed in which the stage 1 panels were fully pretensioned transversely. Half of the transverse pretensioning strands were left protruding from those panels. Stage 2 post-tensioning strand was then coupled on to the protruding stage 1 strands. This detail allows the longitudinal joint to be post-tensioned with added integrity making it less susceptible to deterioration. The second innovative concept deals with using a wider shear stud block out spacing for composite action between the deck and girders. Traditionally shear studs are spaced at 2-foot intervals. The larger 4-foot spacing was justified through testing of a half-scale model. This detail simplifies panel and deck construction.*

**Keywords:** Precast, Prestressed, Bridge Deck Panels, Full Depth Deck Panels, Post Tensioning

## INTRODUCTION

Highway agencies commonly use cast-in-place concrete for building new bridge decks or replacing deteriorated decks. Cast-in-place decks have disadvantages, primarily the construction time and cost associated with forming, placing reinforcement bars, and casting the new deck. For deck replacement projects, this translates to long road closure times.

An alternative to using cast-in-place decks is the use of full-depth precast concrete deck panels. These panels are constructed off-site under controlled conditions and brought to the site ready for placement. The panels are then connected together in place. Construction with precast concrete deck panels takes less time and thus creates less interruption to motorists. In many situations, a bridge can be repaired using only night closures, or in certain circumstances staged construction can be implemented to maintain traffic in both directions. In staged construction, half of the bridge will be replaced while the other half is kept open to traffic. Other advantages include increasing work zone safety by reducing the exposure time as well as the number of workers operating near moving traffic, and reducing environmental impacts by minimizing the site access footprint.

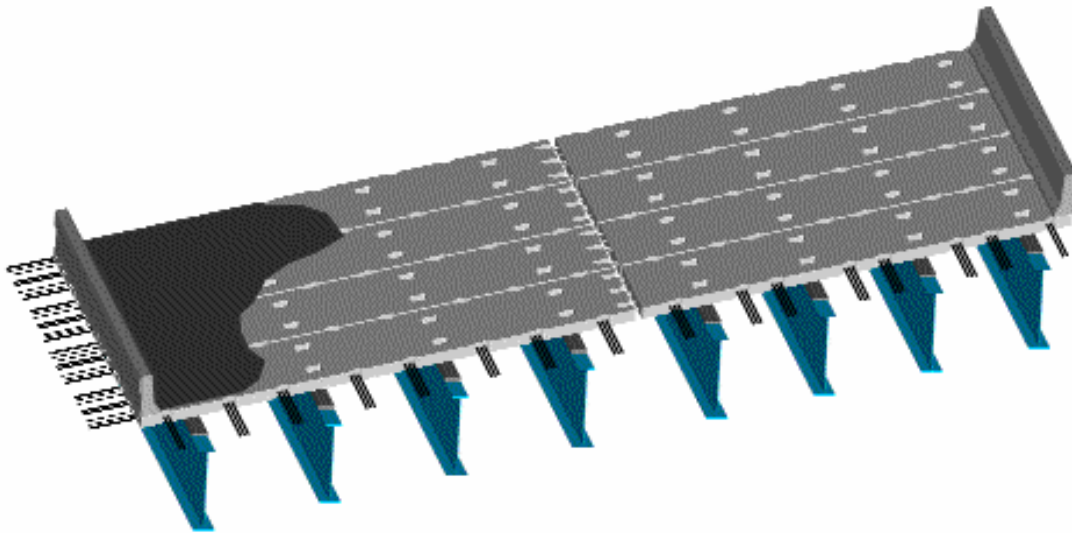

Figure 1: Typical Deck Panel System Schematic

The purpose of the project described here was to investigate the feasibility of utilizing full-depth precast concrete deck panels, schematically shown in Figure 1, for bridge deck replacement projects in Wisconsin. This included investigating previous projects and research related to specific components of the prefabricated system, consulting with the State, local precasters, and post-tensioning suppliers to develop specific design details, and working with a consultant to develop plans and specifications for a prototype bridge.

New methods of construction and detailing were selected for use in Wisconsin. Deck durability under corrosive salt conditions was one of the State's primary design criteria. As such, all joints were to be prestressed (post-tensioned). Laboratory testing was required to prove capacities of the new system and the constructability of details including: determining the appropriate level of post-tensioning required across the longitudinal and transverse joints to prevent cracking of the joints, and developing connection details for connecting the panels to the girders in order to develop composite action.

In August 2005, the results from testing conducted in this research project were incorporated in the widening of an existing bridge on I-39/90 near McFarland, Wisconsin owned by the Wisconsin Department of Transportation. The adjacent twin structure used conventional formwork, steel reinforcing, and cast-in-place concrete for the bridge widening, thus providing a future opportunity to compare construction, performance, and durability of the two systems during construction and in service.

## **PROPOSED PROTOTYPE BRIDGE AND RESEARCH PROGRAM**

The Wisconsin Department of Transportation (WisDOT) proposed, through the Federal Highway Administration's (FHWA) Innovative Bridge Research and Construction (IBRC) program, to develop a precast deck panel system in order to increase construction efficiency and reduce road closure time. This project consists of three phases: conduct research and laboratory tests in order to complete the design, implement the tested design in a prototype bridge deck, and finally, employ a long-term monitoring program. WisDOT contracted with the Civil and Environmental Engineering Department at the University of Wisconsin-Madison. Alfred Benesch & Company (consulting bridge engineers) served as a design subcontractor to UW-Madison, to complete the first two phases which are described here.

The prototype bridge that was widened using the precast deck panel system is on a heavily trafficked section of Interstate 39/90 near Madison, Wisconsin. It is part of a twin bridge system over Door Creek with each bridge carrying two lanes of traffic. Each bridge was an 83'-0" (25.30 m) long single span structure with a 30° skew. The existing bridges originally were 40'-2" (12.24 m) wide, however, part of the project was to widen the bridges to 64'-6" (19.66 m). The bridge originally had five 60" (1,524 mm) deep steel plate girders spaced at 8'-10" (2.69 m) on center; three additional girders were added at 7'-6" (2.29 m) centers to accommodate the widening.

The existing steel plate girders are constructed from grade ASTM A36<sup>1</sup> steel and consist of a 1¼" x 16" (32 x 406 mm) bottom flange, a 3/8" x 60" (10 x 1,524 mm) web, and 5/8" x 12" (16 x 305 mm) top flange; the additional new girders are constructed from ASTM A709<sup>2</sup> Grade 36 steel and consist of a 1" x 16" (25 x 406 mm) bottom flange, a 7/16" x 60" (11 x 1,524 mm) web, and ¾" x 12" (19 x 305 mm) top flange. The haunch between the girders and the bridge deck varies between 1" to 3" (25 to 76 mm) to adjust for camber in the girders and cross slope. Both bridges utilize headed shear studs to achieve composite beam action. Parapets for each structure are constructed from conventionally field formed and steel reinforced concrete.

**SYSTEM COMPONENTS**

The proposed precast system consists of full-depth precast concrete deck panels, which are constructed off-site and brought to the site ready for placement. The panels are then post-tensioned together in place in both the longitudinal and transverse directions. For the prototype bridge, stage construction was utilized, which required that a longitudinal construction joint be present. Figure 2 shows a plan view of the proposed deck panel layout.

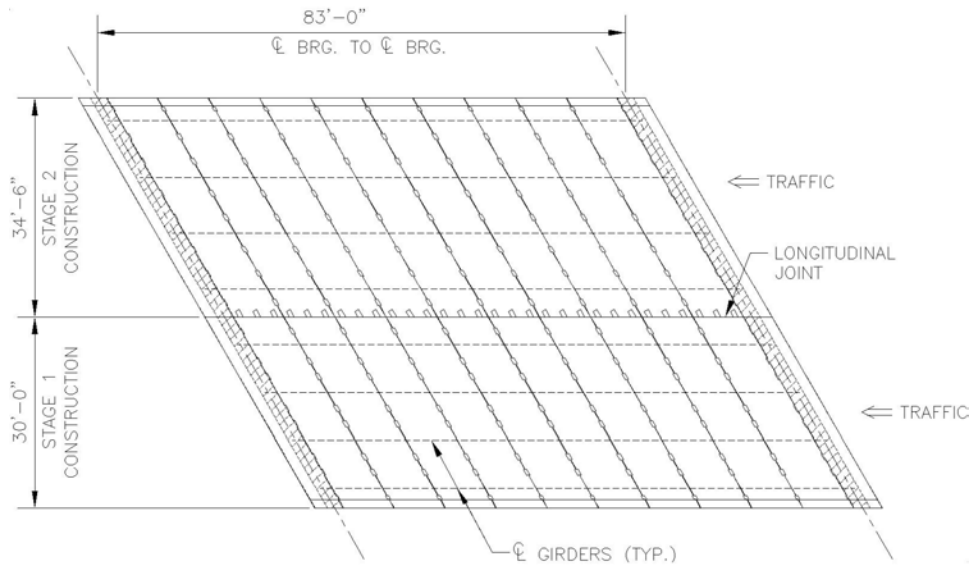

Figure 2: Plan View of Proposed Deck Panel Layout

The ten stage 1 pre-tensioned panels are first placed in position on leveling bolts, transverse joints are grouted and then the panels are post-tensioned together longitudinally. Haunches between the panels and girders are grouted next along with the blockouts where shear studs are attached to the girders. Finally, the deck is milled to provide a smooth driving surface and then receives a two layer epoxy overlay. Epoxy was selected to allow observation of joint behavior over time. A concrete or latex modified concrete overlay, however, was preferred. This sequence of construction is illustrated in Figure 3 and is followed for stage 2 as well. After the steps shown in the chart, the strands in the stage 1 and stage 2 panels are spliced and the deck is post-tensioned transversely.

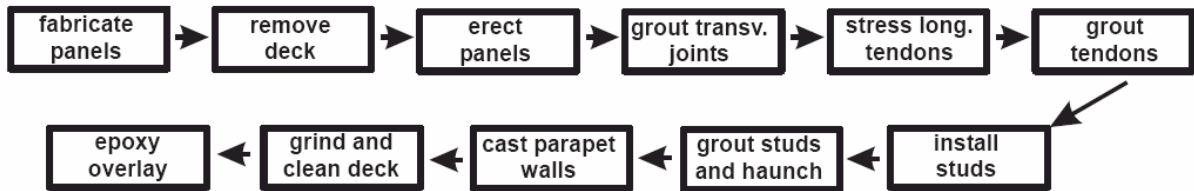

Figure 3: Flow Chart for Construction Sequence

Since the panels were post-tensioned in place for both the longitudinal and transverse directions, post-tensioning ducts had to be placed in both directions. As seen in Figure 4 the longitudinal post-tensioning duct is located in the center of the slab, while the transverse post tensioning ducts are placed above and below the longitudinal ducts. The panel thickness for the Door Creek Bridge is 8 3/4". This is greater than the 8" thickness used in all test specimens. With the combination of ducts and mesh, the top cover on the epoxy coated mesh is less than normal. The epoxy coat on the concrete deck will provide added protection

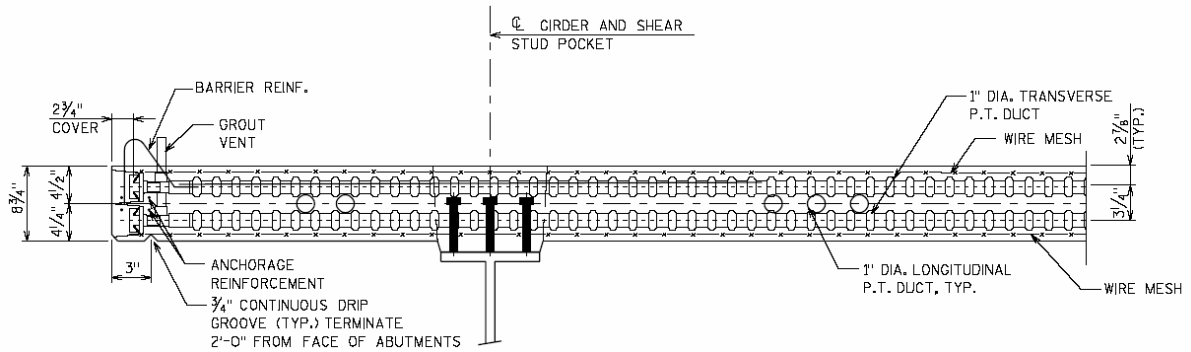

Figure 4: Deck Section Showing Exterior Girder

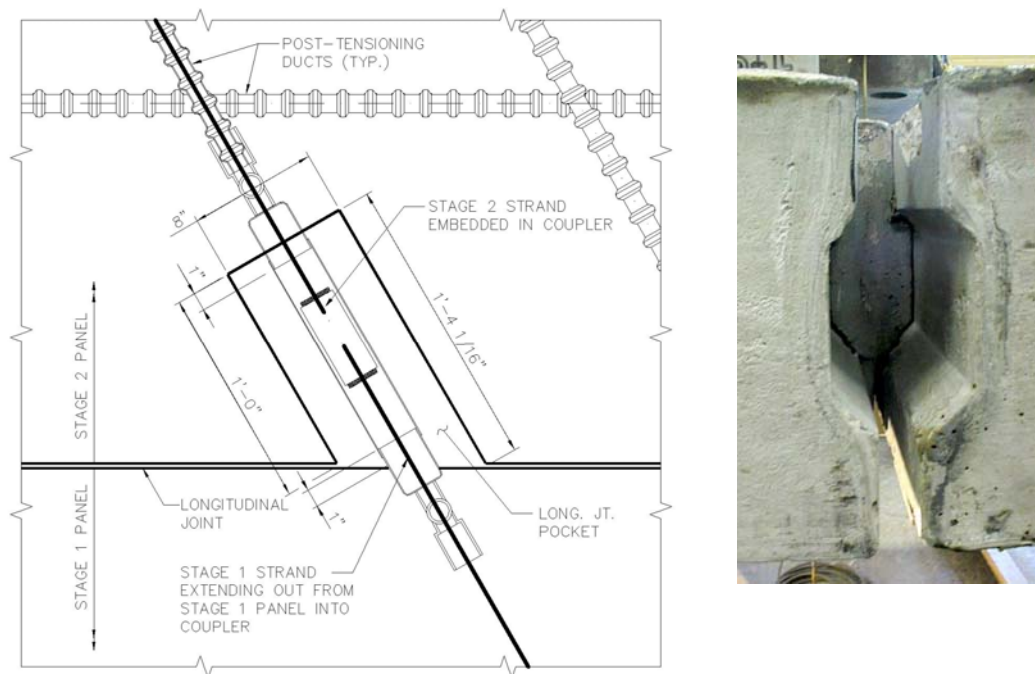

Figure 5: Views of longitudinal joint detail.

### LONGITUDINAL JOINT

The Door Creek Bridge had a staged construction schedule, allowing traffic to be maintained during construction. This construction staging creates a joint between the stage 1 and stage 2 panels shown in Figure 2. This was handled with a post-tensioned female-female joint.

Views of this are shown in Figure 5. These joints, as well as the haunch between the panels and girders, are filled with CG-86 grout from W.R. Meadows.

An innovation of the Door Creek Bridge is in the design and construction of the longitudinal deck joint required for the staged construction. A system was developed in which the stage 1 panels were fully pretensioned transversely to resist panel stresses due to handling, transportation, and placement, as well as vehicle induced bending due to traffic during the stage 2 construction. Only longitudinal post-tensioning was needed before traffic could be applied on stage 1 panels. Roadway crown or cross slope was achieved using flat panels and a “kink” at the longitudinal joint.

Half of the transverse pretensioning strands, spaced at 28.5 in. (42 cm), were left protruding from the stage 1 panels. The transverse post-tensioning ducts in the second stage panels were placed to match the locations of the top and bottom protruding pre-tensioned strands of the stage 1 panels at the longitudinal joint. Post-tensioning strand is placed in these stage 2 panel ducts and then coupled to the protruding strand from the first stage construction. These post-tensioning strands, along with an equal amount of pre-stressing strand already cast into the panel for handling, transportation, and placement, resist vehicle induced bending in stage 2 panels. Part of the design was to prevent any cracking at service load levels. This post-tensioned joint should create a much more durable bridge deck and is ultimately the reason it was incorporated. All ducts were grouted with Sika 300PT prepackaged grout.

A second unique feature is that the longitudinal joint for the prototype bridge is not located over a girder; instead the joint occurs between girders. When traffic is on the stage 1 deck, during stage 2 construction, the cantilevered portion of the deck to this joint had to resist moments from a temporary barrier wall. The moments induced by traffic over the completed joint, however, controlled the design. If the deck cracks at the joint when under traffic load, it will occur at the bottom of the deck rather than the top since the joint is placed in the positive moment region. This should reduce ingress of salt solutions and leakage along the joint, making the deck more durable.

If the joint were to be placed over a girder, extra detailing would be required so that the shear studs would not conflict with the panel coupling detail occurring at the joint. This would create unwanted congestion at the joint, which would make the detail more difficult to construct. A joint over the top of the girder might also allow undesirable salt solution intrusion on the girder itself if top of slab cracking developed.

## SHEAR STUDS

Bridges that may experience unusual forces such as hurricane uplift or seismic force effects may need special ties or shear studs between the girders and the deck to maintain the integrity of the bridge. Most often, however, shear studs are used to develop composite action where the deck works with the girders in resisting longitudinal flexure.

To achieve full composite action between the precast deck panels and girders, whether steel or concrete, shear connector block-outs are provided within precast deck panels. Headed shear studs (or stirrups in precast concrete beam girder construction) that are attached to the girder extend into these block-outs to achieve the desired composite action. The number of studs or stirrups in each pocket is usually based on the American Association of State Highway and Transportation Officials<sup>3</sup> design requirements. Based on previous projects<sup>4</sup> with decks on steel girders, the maximum shear stud spacing or distance between shear stud block-outs is 2 ft (610 mm), which conforms to AASHTO, both LRFD<sup>3</sup> and the Standard Specifications<sup>5</sup> design limits. The writers believe this limit is a safe “rule-of-thumb” limit imposed by the AASHTO to assure complete composite action and avoid fatigue conditions. In most circumstances this spacing is based on the fatigue capacity of the studs, and not the ultimate capacity. With precast panels it is beneficial, however, to place the shear connector block outs at the largest spacing possible. This allows for fewer block outs in the panels, which in turn increases panel strength for shipping and decreases manufacturing time and cost. An alternate spacing of 4 ft (1,220 mm) is used on the Door Creek bridge.

The original shear connectors on the existing steel girders of the Door Creek bridge are removed and the new studs are placed in the pockets after all of the panels are positioned and post-tensioned longitudinally. The pockets are subsequently grouted along with the haunches between the girders and panels. Achieving a shear connection with an existing prestressed concrete girder would be more difficult, but would likely entail attaching steel plates to the top of the girders, to which studs would be welded later.

## **SYSTEM TESTING**

The laboratory testing was carried out at the Structures and Materials Testing Laboratory at the University of Wisconsin-Madison. The panels were tested with MTS closed-loop servo hydraulic actuator test equipment. Joint specimens were tested with a 200 kip (890 kN) capacity actuator. The composite beam specimen was loaded by a 100 kip (445 kN) capacity actuator. The actuators were each mounted on rigid steel frames that were anchored into a structural testing floor.

## **JOINT TESTS**

These tests were used to verify the amount of post-tensioning stress required across the joints to maintain tightness or deck stiffness under service level vehicle loads. Previous research had shown that a 200-psi (1.4 MPa) prestress should be used for transverse joints in a simple span bridge<sup>6</sup>. No prestress levels were suggested for a longitudinal joint. Our aim was to identify the prestress level needed to maintain overall deck stiffness, not the level needed to completely prevent crack opening. Small crack opening was deemed acceptable if it developed only at the bottom of the deck slab. A total of three full-scale longitudinal joint tests were conducted. Each test had a different amount of prestress across the joint: 360 psi (2.5MPa), 338 psi (2.3 MPa), and 232 psi (1.6 MPa).

In addition to determining the joint capacity, two of the longitudinal joint tests were loaded in a manner to create cyclic vertical movement in one of the slabs while the grout in the longitudinal joint was curing. This needed to be examined to measure the effects, if any, that the movement from traffic on one side of staged construction could have on the hardening joint grout.

Application of uniform moment on the joint was accomplished by applying a concentrated line load, distributed evenly across the width of the panel above the joint. All specimens were 8" (200 mm) thick and 4' (1.22 m) wide. The longitudinal joint test was set up as a 3 span continuous beam, with the spans measuring 8'-10" (2.69 m) and the center span loaded; Figure 6 shows the test configuration. The joint was located at mid-span of the interior span. The tests loaded the panels until first joint opening, which defined an acceptable serviceability load level. Vertical displacement, bottom of joint opening and top of joint strain were recorded during testing.



Figure 6: Three span test configuration of the longitudinal joint test.

### COMPOSITE BEAM TEST

To determine whether the deck could be attached to girders at a wider than normal connector spacing, a test was conducted to compare performance with varied connector spacing between the concrete deck panels and a steel plate girder. This was conducted on a half-scale model of girders from the Door Creek Bridge. The panels were 4 inches (100 mm) thick and were 4ft (1.22 m) wide by 4ft (1.22 m) long.

Only one test specimen was built, however, two different shear stud layouts were used on either side of the centerline of the steel plate girder. One end of the beam utilized a shear stud spacing of 2ft (0.61 m) [equal to 4ft (1.22 m) at full-scale], while the other end utilized a 1ft (0.31 m) spacing [2ft (0.61m) at full-scale].

The test was conducted on a simple span beam of 41.5ft (12.65 m), half scale for the Door Creek Bridge. Figure 7 shows the test configuration for the composite beam test with the



point load applied at midspan. The test included an accelerated fatigue cyclic loading to check the long-term fatigue durability of the connection system. After the fatigue process, the beam was loaded to an equivalent AASHTO service load limit. This provided a measure of how effectively deflections can be calculated at the service load level using typical calculation methods. Finally, the beam was loaded to a large overload and the performance of the different shear stud configurations compared.



Figure 7: Test configuration for the composite beam test.

## RESULTS

The main purpose of the experimental testing was to investigate specific components of the prefabricated panel system. In particular the required prestress levels, fatigue performance and identification of the ultimate and service load capacities of the system. Only selected test results and conclusions are presented here; further detailed data are described by Markowski.<sup>7</sup>

### JOINT TESTS

The point at which the longitudinal joint first cracked is defined based on a moment per foot of width rather than a test load. This gives a better measure of the joint behavior for design applications. Figure 8 shows the joint moment versus vertical displacement under the load for the different joint prestress levels. Each individual curve is labeled with the amount of prestress applied and the moment at which a loss of stiffness occurred with joint cracking. Table 1 displays the values of the joint moment for which initial cracking was observed in the bottom of the joint.

The design service moment is calculated for the Door Creek Bridge using the AASHTO Standard Specification<sup>5</sup>. The moment is in units per foot width of panel and includes an

impact factor of 1.3. The joint cracking moments are compared to the service load moment, plus impact, based on an HS-20 truck. From these comparisons a factor of safety (F.S.) is shown against cracking.

It is clear from comparing the response of specimens LJ-1 and LJ-2 that cyclic motion of a grouted joint during grout cure did not affect the joint structural behavior. Specimen LJ-2 experienced 0.015 inches (0.38 mm) of cyclic vertical motion in one panel while the grout between panels at the longitudinal joint cured. This amount of motion is what was predicted to occur in the Door Creek panel with and AASHTO HS-20 loading. The grout in specimen LJ-1 was allowed to cure without motion. The initial stiffnesses (slopes) for both specimens are nearly identical in Figure 8. The difference in behavior at high load (> double service load) is a result of the higher prestress level in specimen LJ-1.

Transverse joint moments and joint behavior were also examined at a 154 psi (1.1MPa) prestress. The deck service load moment for the transverse joint TJ-1 in Table 1 (the longitudinal moment parallel to the girders) is based on the AASHTO design method. AASHTO presents criteria for distribution reinforcement in the bottom of slabs when main reinforcement is perpendicular to the direction of traffic. According to AASHTO, longitudinal distribution reinforcement shall be 67% of the positive main transverse reinforcement in the slab. The longitudinal design service load moment was thus taken as 67% of the calculated transverse design moment.

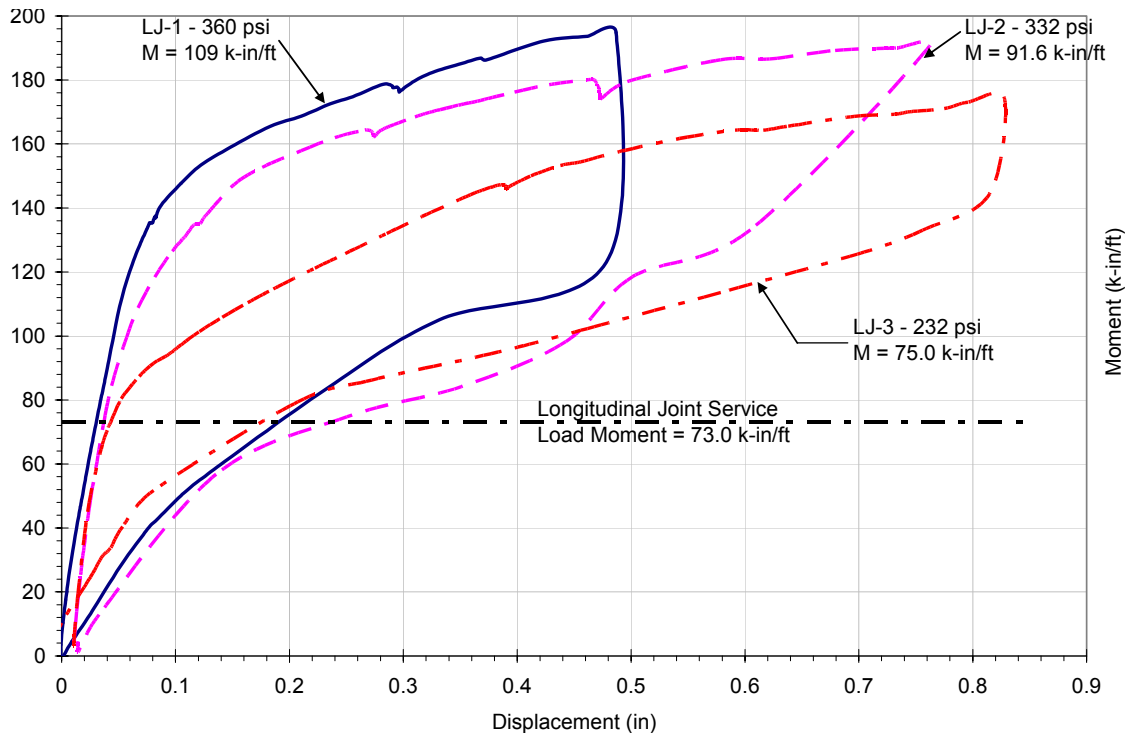

Figure 8: Joint moment versus vertical displacement for the three different joint prestress levels. (Note: 1 k-in/ft = 0.37 kN-m/m, 1 in. = 25.4 mm, 1 psi = 6.89 kPa)

Table 1: Table comparing moments per foot of width at which first cracking occurs in bottom of joint with service load moments for both the longitudinal and transverse joints. (LJ = longitudinal joint, TJ = transverse)

Test (Joint PT Level)	First Crack @ Bott. Joint Moment (k-in/ft)	Longitudinal Joint Service Load Moment+IM (k-in/ft)	Transverse Joint Service Load Moment+IM (k-in/ft)	safety factor Longitudinal Joint Cracking	safety factor Transverse Joint Cracking
LJ-1 (358.7 psi)	109	73.0	49.0	1.50	2.22
LJ-2 (337.5 psi)	91.6	73.0	49.0	1.25	1.87
LJ-3 (232 psi)	75.0	73.0	49.0	1.03	1.53
TJ-1 (154 psi)	62.4	73.0	49.0	0.85	1.27
1 k-in/ft = 0.37 kN-m/m, "IM" = impact effect, "FS" = factor of safety					

## COMPOSITE BEAM TEST

Fatigue cyclic loading to two million cycles produced no measurable effects in the composite beam. As described above, after accelerated fatigue loading the composite beam was reloaded to a service load level. The measured composite girder midspan displacement under service load is shown in Figure 9. The maximum beam deflection recorded by the LVDT was 0.6847 inches (17.4 mm) at 43.5 kips (193 kN).

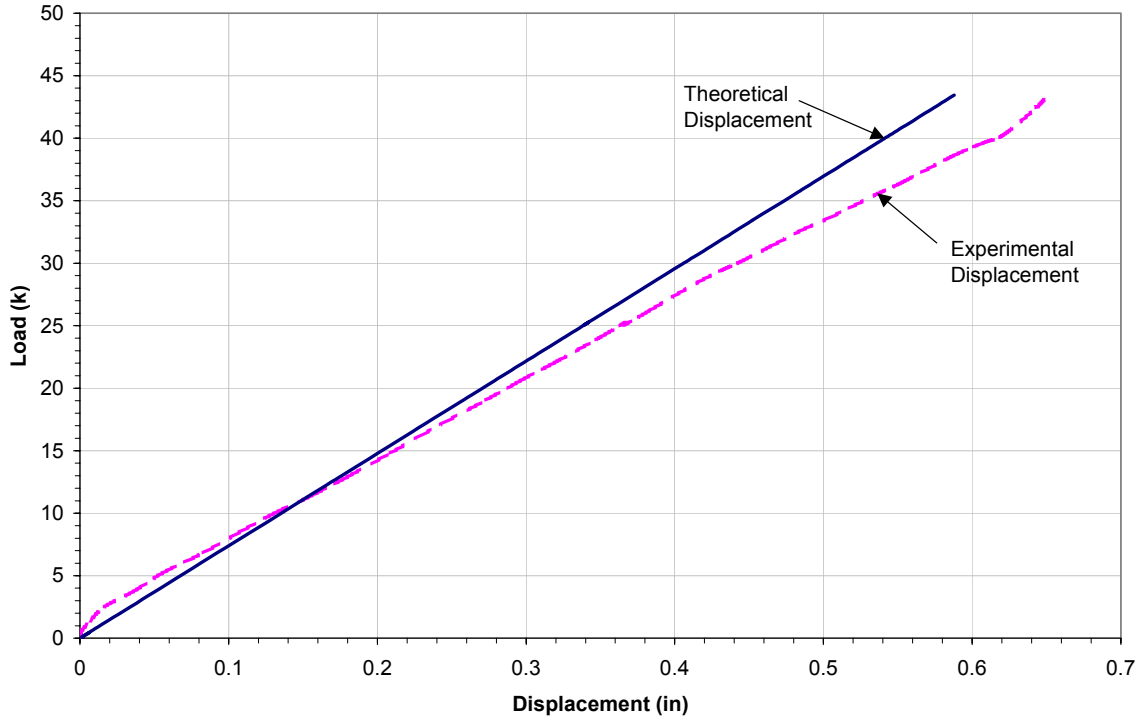

Figure 9: Load versus average mid-span displacement. (Note: 1 k = 4.45 kN, 1 in. = 25.4 mm)

By using Figure 9, the stiffness (k/in or kN/mm) of the beam can be determined in the elastic range. From this stiffness an effective transformed moment of inertia ( $I_{tran}$ ) can be found by using the deflection equation for a simply supported beam with a concentrated load at mid-span.

$$\Delta = \frac{Pl^3}{48E_s I_{tran}} \quad (1)$$

Rearranging equation 1 such that it is in the form of stiffness (k/in or kN/mm):

$$\frac{P}{\Delta} = \frac{48E_s I_{tran}}{l^3} \quad (2)$$

The secant stiffness, within the service load range, was calculated from Figure 9 and was found to be 70 k/in (12.3 kN/mm). This stiffness is equal to the left hand side of equation 2; the equation can then be solved for “ $I_{tran}$ ”. The effective transformed moment of inertia was calculated to be 5,844 in<sup>4</sup> (2,432x10<sup>6</sup> mm<sup>4</sup>), or approximately 95% of the theoretical fully composite transformed moment of inertia of 6,170 in<sup>4</sup> (2,568x10<sup>6</sup> mm<sup>4</sup>). The theoretical fully composite transformed moment of inertia was calculated using the concrete modulus of elasticity found from strain gages placed on the concrete cylinders when testing for compressive strength. The calculated effective “ $I_{tran}$ ” shows that there is indeed good composite action occurring within the service limit range.

## CONSTRUCTION

Placement of a phase one precast panel on the Door Creek bridge is shown in Figure 10. On the left side of the panel the reinforcing steel loops for a cast in place parapet wall extend above the surface. Sets of three longitudinal post-tensioning ducts exit from the edge on the near side of the panel. The longitudinal joint will be created on the right side of the panel after traffic is moved from the existing deteriorated bridge deck (at far right) and onto the new precast deck.

Erection of the phase 1 precast deck went fast and well. Construction was slowed for a short time when grout that was placed in the transverse joints was found to have leaked into some of the post-tensioning ducts. The problem was traced to a construction error when the ducts in adjacent panels were poorly spliced. The grout was removed from the ducts and construction continued.

The primary change that would be made in construction of a future deck is in the use of flat ducts for post-tensioning carrying three strands, rather than the three individual ducts in groups that are shown in Figure 10. A single duct would significantly reduce the field time required to splice ducts at the panel joints.



## PLANS FOR DEVELOPING GENERAL DESIGN PROCEDURES

With further detailed examination of the data from tests and the bridge construction, design guidelines for future use of the proposed deck panel system will be established. This will include developing a Finite Element Model (FEM) of the constructed bridge and using the experimentally measured joint behavior to model joint stiffness. An accurate FEM, along

with experimental and analytical data analysis, will help in structurally optimizing the prestressing levels required in precast decks and the system as a whole.

## CONCLUSIONS AND SUMMARY

Based on the different prestress levels tested, a prestress level of 360 psi (2,480 kPa) across the longitudinal joint gives a 1.5 factor of safety against cracking at a service load level. Similarly a prestress level of 232 psi (1.6 MPa) gives a 1.53 factor of safety against cracking in a transverse joint. The longitudinal and transverse joints are stressed to 360 psi and 250 psi (2.48 MPa and 1.72 MPa) in the Door Creek Bridge, respectively<sup>7</sup>.

Shear stud connector block outs spaced at the larger spacing than AASHTO normally allows exhibited good composite action within the elastic range. Fatigue loading had little effect on the performance of the beam regardless of the shear connector block out spacing<sup>7</sup>.

Cyclic movement of grouted joints, at small amplitudes, while grout is hardening has little effect on the subsequent behavior of the joint after it is post-tensioned.

## REFERENCES

1. ASTM A 36, "Standard Specification for Carbon Structural Steel," ASTM International.
2. ASTM A 709, "Standard Specification for Carbon and High-Strength Low-Alloy Structural Steel Shapes, Plates, and Bars and Quenched-and-Tempered Alloy Structural Steel Plates for Bridges," ASTM International.
3. AASHTO. "LRFD Bridge Design Specifications", American Association of State Highway and Transportation Officials, Third Edition, 2004, Washington D.C.
4. Issa, M., Yousif, A., Issa, M.A., Kaspar, I., Khayyat, S., (1995). "Field Performance of Full Depth Precast Concrete Panels in Bridge Deck Reconstruction", *PCI Journal*, Vol. 40, No. 3, May-Jun 1995, pp. 82-108.
5. AASHTO. "Standard Specifications for Highway Bridges", American Association of State Highway and Transportation Officials, 16<sup>th</sup> Edition, 1996, Washington D.C.
6. Issa, M., Yousif, A., Issa, M.A., Kaspar, I., Khayyat, S., (1998). "Analysis of Full Depth Precast Concrete Bridge Deck Panels", *PCI Journal*, Vol. 43, No. 1, Jan-Feb 1998, pp. 74-85.
7. Markowski, S., (2005) "Experimental and Analytical Study of Full-Depth Precast / Prestressed Concrete Deck Panels for Highway Bridges", M.S. Thesis, Department of Civil and Environmental Engineering, University of Wisconsin-Madison.